

Circular Bollard

LGT.30.106.02



H : 500mm

SAFETY

The installation and operation of this luminaire are subject to national safety regulations. Installation and commissioning may only be carried out by a qualified electrician. The manufacturer accepts no liability for damage caused by improper use or installation. If subsequent modifications are made to the luminaire, the person responsible for these modifications shall be considered the manufacturer.

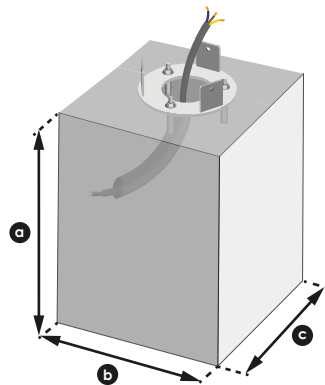

a	300mm
b	300mm
c	300mm
d	M8

1 1 steel flange required during assembly is available as mounted on the product. Steel dowel (3xM8) must be provided by the assembly team.

- Pour the foundation concrete as given dimensions to have safe and durable bollard installation. At least 50 cm main electrical cable should set free from the concrete surface level to have safe and more convenient electrical wire connection.
- Use spirit level and take into consideration while setting the flange on the concrete surface.

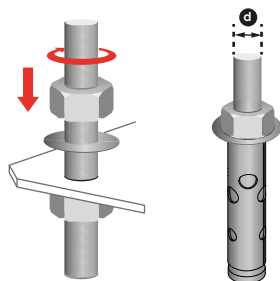

2 After flange set on the surface, mark the steel dowel holes. Drill the steel dowel holes with a suitable drill. Then place the steel dowels without nuts on the flange surface. Use the nuts to fix flange into the concrete ground. Next step will be the connection of cables.

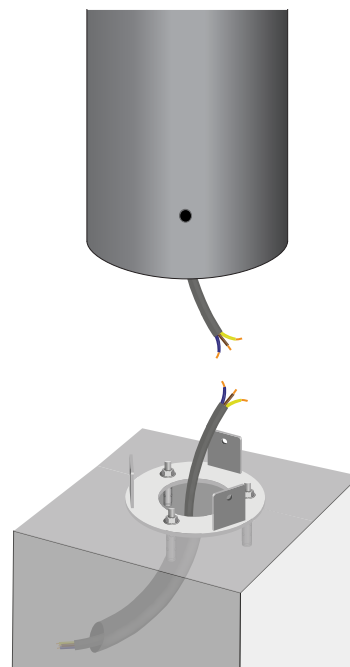

- 3** Please use the electrical connection table to connect cables. Be sure that earthing connection has done.
- Please control and be sure that the isolation completed according to outdoor conditions.

Electrical Connection

On-Off	
220-240V AC ~ 50-60Hz	N ⊕ BLUE
	⊕ ⊕ GREEN YELLOW
	L ⊕ BROWN

On-Off
 Brown : F
 Blue : N
 Yellow-Green : Ground
 Black : DALI (+)
 Gray : DALI (-)

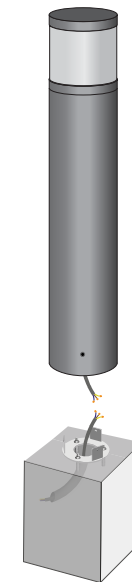

- 4** After cable connection, mount the product to the flange with 3 nos screws.

